

TECHNICAL SPECIFICATIONS HOSE REEL WITHOUT SHOWER :

Hose length in meters	10 m
Maximum Working pressure	maximum 20 bar Air - maximum 10 bar Water
Maximum Working temperature	maximum 25°C Air - maximum 70°C Water
Weight	5,3 Kg
Can be used to transfer	Air-Water

SHOWER :
Working temperature : maximum 70°C
Working pressure : maximum 6 Bar

AUTOMATIC HOSE REEL
cod. 00803000056

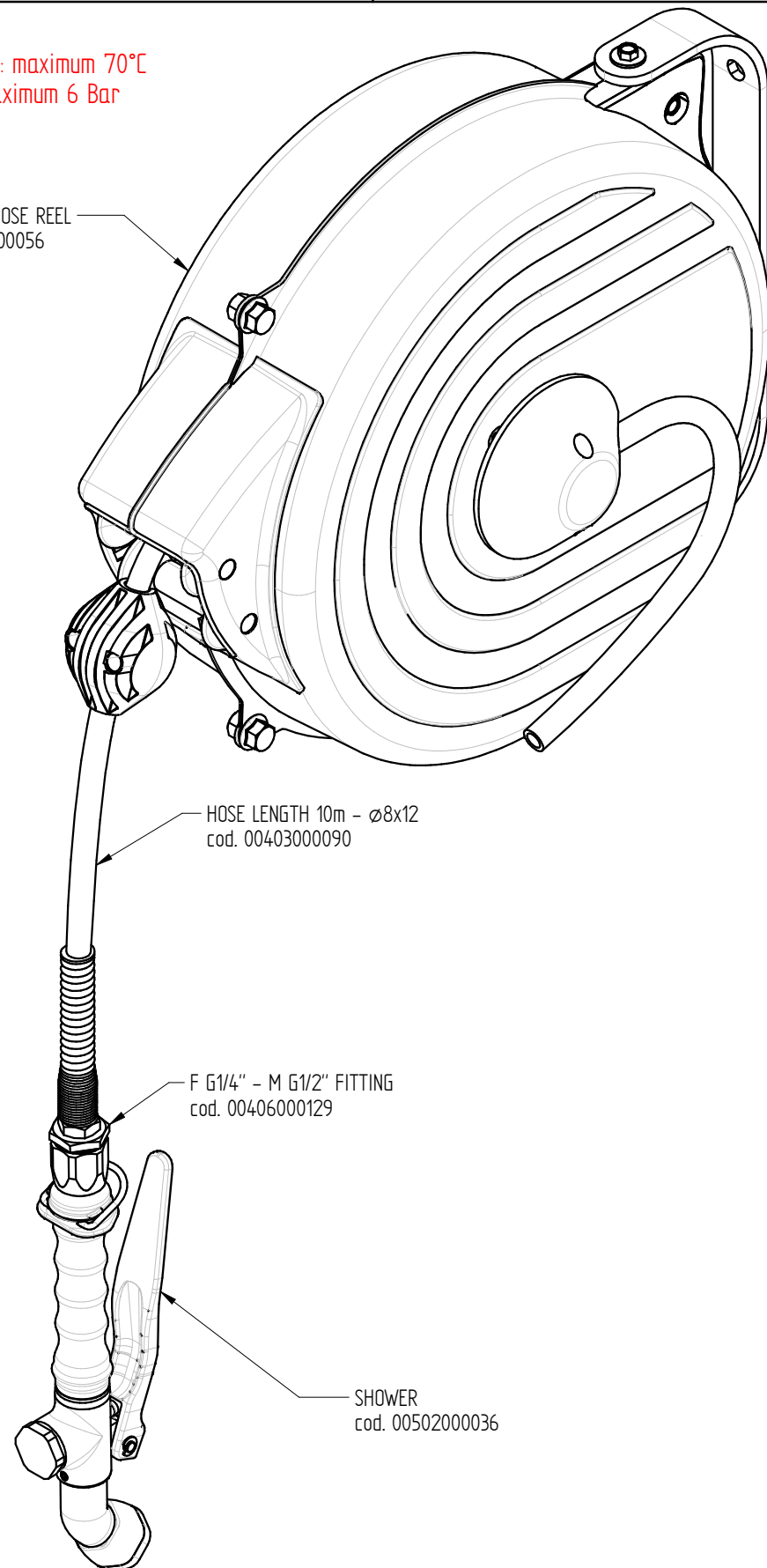

HOSE LENGTH 10m - \varnothing 8x12
cod. 00403000090

F G 1/4" - M G 1/2" FITTING
cod. 00406000129

SHOWER
cod. 00502000036

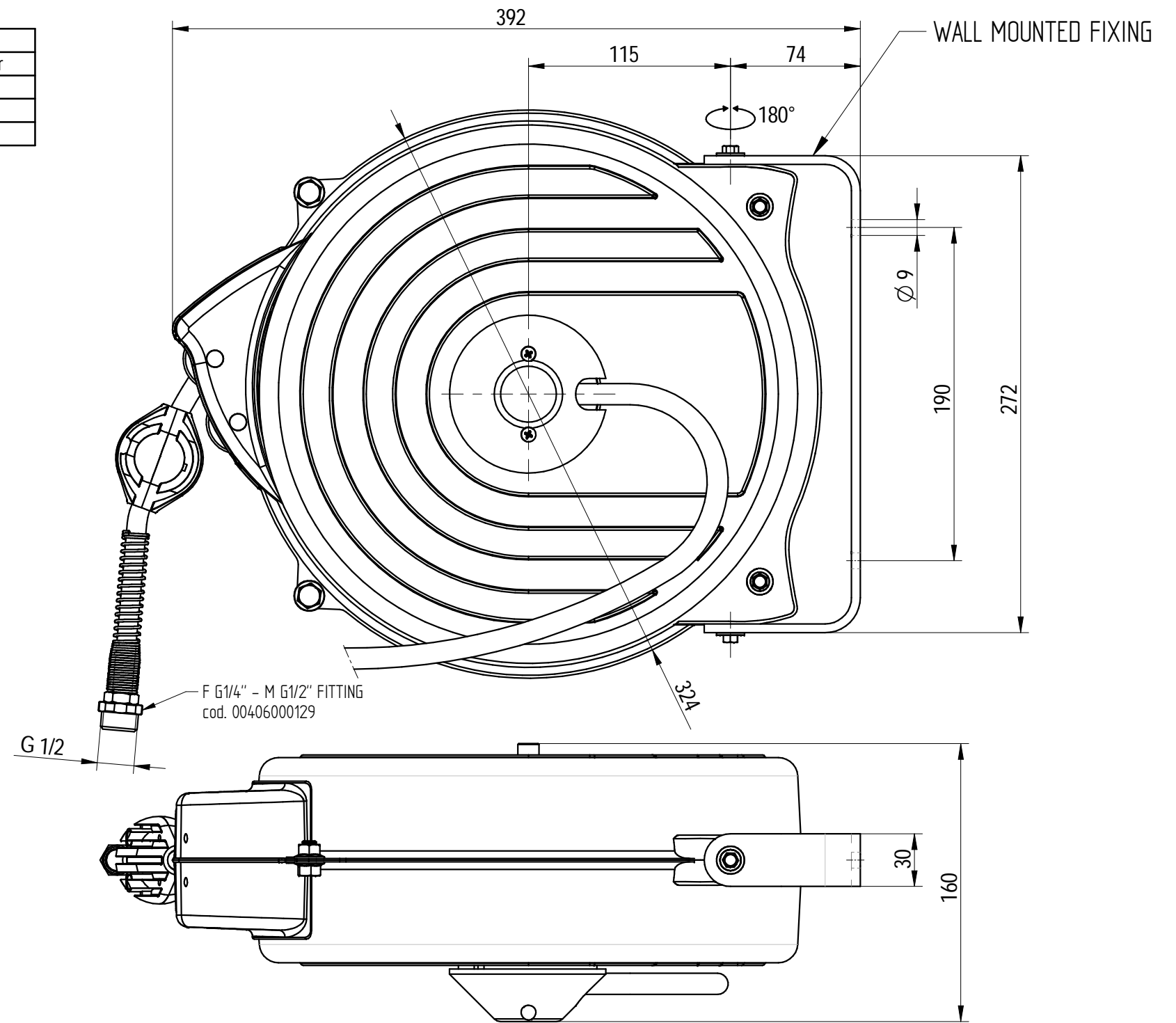

FLOW RATE : 6 L/min at 3,5 BAR

Shares without tolerance according to standard UNI-EN-22768-1-m		DESCRIPTION	CODE
SIZE	A3	STAINLESS STEEL WALL MOUNTED COVERED HOSE REEL L=10m WITH FOOD QUALITY HOSE AND SHOWER	SR000000034A
DATE	05-11-2018		WEIGHT
			5,8 Kg
DRAWN	PICCOLO M.	 DESIGN AND TECHNOLOGICAL RESEARCH FOR WATER VIA DELL'ARTIGIANO 8/F-8-G , 31050 MONASTIER di TREVISO (TV) tel: 0422 842157 - fax: 0422 708978	
VALIDATE	PICCOLO M.		
DONE WITH DESIGN CAD - PROHIBITED THE CHANGES MANUAL			